

R package: 1200V 75A IGBT module

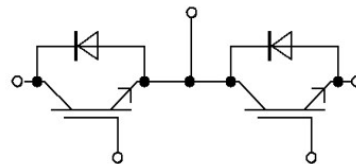

Equivalent Circuit Schematic

### Features:

- 1200V 75A,  $V_{CE(sat)} = 2.50V$
- planar field-stop technology
- High RBSOA capability
- Low turn-off losses

### 产品特性:

- 1200V 75A,  $V_{CE(sat)} = 2.50V$
- 平面栅场终止技术
- 高 RBSOA 性能
- 低关断损耗

### Typical Applications:

- Inductive Heating
- Welding
- High Frequency Switching Application

### 典型应用:

- 感应加热
- 电焊机
- 高频开关应用

## IGBT, Inverter / IGBT, 逆变部分

### Maximum Rated Values / 最大标称参数

Collector-emitter Voltage 集电极-发射极电压	$T_{vj}=25^{\circ}\text{C}$	$V_{CES}$	1200	V
Continuous DC collector current 集电极连续直流电流		$I_{C\text{ nom}}$	75	A
	$T_C=80^{\circ}\text{C}, T_{vj\text{ max}}=150^{\circ}\text{C}$	$I_C$	80	A
Repetitive Peak collector current 集电极可重复峰值电流	$I_{CRM}=2 \times I_{C\text{ nom}}$	$I_{CRM}$	150	A
Total power dissipation 总功率损耗	$T_C=25^{\circ}\text{C}, T_{vj\text{ max}}=150^{\circ}\text{C}$	$P_{\text{tot}}$	445	W
Gate-emitter peak voltage 门极-发射极峰值电压		$V_{GES}$	$\pm 20$	V

### Characteristic Values / 性能参数

				min.	typ.	max.	
Collector-emitter saturation Voltage 集电极-发射极饱和压降	$I_C=75\text{A}, V_{GE}=15\text{V}$	$T_{vj}=25^{\circ}\text{C}$	$V_{CESat}$		2.50	3.10	V
	$I_C=75\text{A}, V_{GE}=15\text{V}$	$T_{vj}=125^{\circ}\text{C}$			3.00		
	$I_C=75\text{A}, V_{GE}=15\text{V}$	$T_{vj}=150^{\circ}\text{C}$			3.00		
Gate Threshold Voltage 门极阈值电压	$V_{CE}=V_{GE}, I_C=1\text{mA},$	$T_{vj}=25^{\circ}\text{C}$	$V_{GEth}$	5.0	6.0	7.0	V
Gate Charge 门极电荷	$V_{GE} = -15\text{V} \dots +15\text{V}$		$Q_G$		0.53		nC
Internal Gate Resistor 内置门极电阻	$T_{vj}=25^{\circ}\text{C}$		$R_{Gint}$		5		$\Omega$
Input Capacitance 输入电容	$V_{CE} = 25\text{V}, V_{GE} = 0\text{V}$ $f = 1\text{MHz}$		$C_{ies}$		3.2		nF
Reverse Transfer Capacitance 反向传输电容			$C_{res}$		0.15		nF
Collector-emitter Cutoff Current 集电极-发射极关断漏电流	$V_{CE}=1200\text{V}, V_{GE}=0\text{V},$	$T_{vj}=25^{\circ}\text{C}$	$I_{CES}$			1	mA
Gate-emitter Leakage Current 门极-发射极漏电流	$V_{CE}=0\text{V}, V_{GE}=\pm 20\text{V},$	$T_{vj}=25^{\circ}\text{C}$	$I_{GES}$			$\pm 200$	nA
Turn-on Delay Time, Inductive Load 开通延迟时间, 感性负载	$I_C=75\text{A}, V_{CE}=600\text{V}$ $V_{GE} = \pm 15\text{V}$ $R_{Gon}=1.0\Omega$	$T_{vj}=25^{\circ}\text{C}$	$t_{don}$		38		ns
		$T_{vj}=125^{\circ}\text{C}$			39		
		$T_{vj}=150^{\circ}\text{C}$			39		
Rise Time, Inductive Load 上升时间, 感性负载	$I_C=75\text{A}, V_{CE}=600\text{V}$ $V_{GE} = \pm 15\text{V}$ $R_{Gon}=1.0\Omega$	$T_{vj}=25^{\circ}\text{C}$	$t_r$		25		ns
		$T_{vj}=125^{\circ}\text{C}$			28		
		$T_{vj}=150^{\circ}\text{C}$			30		
Turn-off Delay Time, Inductive Load 关断延迟时间, 感性负载	$I_C=75\text{A}, V_{CE}=600\text{V}$ $V_{GE} = \pm 15\text{V}$ $R_{Goff}=1.0\Omega$	$T_{vj}=25^{\circ}\text{C}$	$t_{doff}$		160		ns
		$T_{vj}=125^{\circ}\text{C}$			195		
		$T_{vj}=150^{\circ}\text{C}$			200		
Fall Time, Inductive Load 下降时间, 感性负载	$I_C=75\text{A}, V_{CE}=600\text{V}$ $V_{GE} = \pm 15\text{V}$ $R_{Goff}=1.0\Omega$	$T_{vj}=25^{\circ}\text{C}$	$t_f$		30		ns
		$T_{vj}=125^{\circ}\text{C}$			80		
		$T_{vj}=150^{\circ}\text{C}$			105		
Turn-on energy loss per pulse 开通损耗	$I_C=75\text{A}, V_{CE}=600\text{V},$ $L_o=80\text{nH}, V_{GE}=\pm 15\text{V}$ $V_{GE} = \pm, R_{Gon}=1.0\Omega$	$T_{vj}=25^{\circ}\text{C}$	$E_{on}$		5.7		mJ
		$T_{vj}=125^{\circ}\text{C}$			9.0		
		$T_{vj}=150^{\circ}\text{C}$			10.0		
Turn-off energy loss per pulse 关断损耗	$I_C=75\text{A}, V_{CE}=600\text{V},$ $L_o=80\text{nH}, V_{GE}=\pm 15\text{V}$ $V_{GE} = \pm 15\text{V}, R_{Goff}=1.0\Omega$	$T_{vj}=25^{\circ}\text{C}$	$E_{off}$		2.4		mJ
		$T_{vj}=125^{\circ}\text{C}$			3.8		
		$T_{vj}=150^{\circ}\text{C}$			4.0		

Thermal Resistance, Junction to Case 结-壳热阻	Per IGBT/单个 IGBT	$R_{thJC}$		0.280		K/W
Temperature under switching conditions 工作温度		$T_{vj\ op}$	-40		150	°C

### Diode, Inverter / 二极管, 逆变部分

#### Maximum Rated Values / 最大标称参数

Repetitive peak reverse voltage 可重复反向峰值电压	$T_{vj}=25^{\circ}C$	$V_{RRM}$		1200		V
Continuous DC Forward Current 可连续正向直流电流		$I_F$		75		A
Repetitive Peak Forward Current 可重复正向峰值电流	$I_{CRM}=2 \times I_{C_{nom}}$	$I_{FRM}$		150		A

#### Characteristic Values / 性能参数

				min.	typ.	max.	
Forward Voltage 正向通态压降	$I_F=75A, V_{GE}=0V$ $I_F=75A, V_{GE}=0V$ $I_F=75A, V_{GE}=0V$	$T_{vj}=25^{\circ}C$ $T_{vj}=125^{\circ}C$ $T_{vj}=150^{\circ}C$	$V_F$		1.90 1.95 1.95	2.50	V
Peak Reverse Recovery Current 反向恢复峰值电流	$I_F=75A, V_R=600V$ $-di_F/dt=1430A/us$ ( $T_{vj}=25^{\circ}C$ ) $V_{GE}=-15V$	$T_{vj}=25^{\circ}C$ $T_{vj}=125^{\circ}C$ $T_{vj}=150^{\circ}C$	$I_{RM}$		60 60 60		A
Recovery Charge 反向恢复电荷	$I_F=75A, V_R=600V$ $-di_F/dt=1430A/us$ ( $T_{vj}=25^{\circ}C$ ) $V_{GE}=-15V$	$T_{vj}=25^{\circ}C$ $T_{vj}=125^{\circ}C$ $T_{vj}=150^{\circ}C$	$Q_R$		4.7 8.7 10.0		$\mu C$
Reverse Recovery Energy 反向恢复损耗	$I_F=75A, V_R=600V$ $-di_F/dt=1430A/us$ ( $T_{vj}=25^{\circ}C$ ) $V_{GE}=-15V$	$T_{vj}=25^{\circ}C$ $T_{vj}=125^{\circ}C$ $T_{vj}=150^{\circ}C$	$E_{rec}$		2.2 4.0 4.8		mJ
Thermal Resistance, Junction to Case 结-壳热阻	Per Diode / 单个 Diode	$R_{thJC}$			0.507		K/W
Temperature under switching conditions 工作温度		$T_{vj\ op}$	-40			150	°C

**Module / 模块**

Isolation Test Voltage 绝缘测试电压	RMS, f=50Hz, t=1min	$V_{ISOL}$	3.0	KV
Material of Module Baseplate 模块底板材料			Cu	
Internal Isolation 内部绝缘	基本绝缘 (class 1, IEC 61140) Basic insulation (class1,IEC 61140)		$Al_2O_3$	
Creepage Distance 爬电距离	端子-散热片 terminal to heatsink 端子-端子 terminal to terminal		17.0 20.0	mm
Clearance 电气间隙	端子-散热片 terminal to heatsink 端子-端子 terminal to terminal		17.0 9.5	mm
Comparative Tracking Index 相对漏电起痕指数		CTI	>200	

		min. typ. max.			
Thermal resistance, case to heatsink 外壳-散热器热阻	每个模块/per module $\lambda_{Paste} = 1W/(m \cdot K) / \lambda_{grease} = 1W/(m \cdot K)$	$R_{thCH}$		0.05	K/W
Stray Inductance Module 模块杂散电感		$L_{sCE}$		30	nH
Module Lead Resistance, Terminals-Chip 模块引脚电阻, 端子-芯片	$T_C = 25^\circ C$ , 每个开关 per switch	$R_{CC'+EE'}$		0.65	m $\Omega$
Storage Temperature 贮存温度		$T_{stg}$	-40	125	$^\circ C$
Modul Mounting torque 模块安装扭距	M6	M	3.0	5.0	Nm
Terminal Mounting torque 端子安装扭距	M5	M	2.5	6.0	Nm
Weight 重量		G		145	g

输出特性 IGBT, 逆变器(典型值)

Output characteristic IGBT Inverter (typical)

$I_C = f(V_{CE})$ ,

$V_{GE} = 15V$

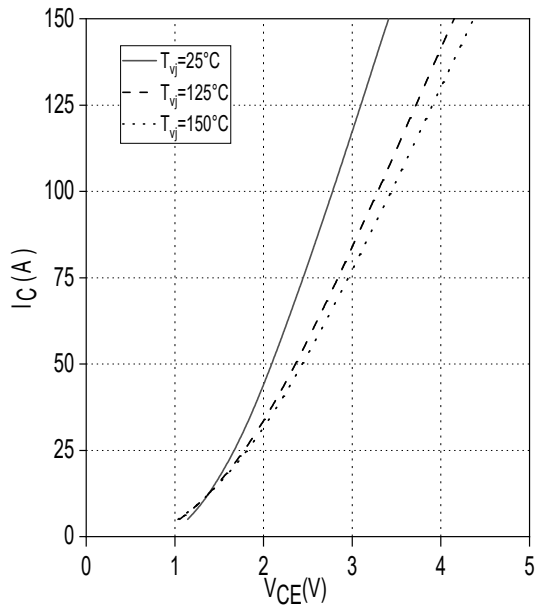

输出特性 IGBT, 逆变器(典型值)

output characteristic IGBT Inverter (typical)

$I_C = f(V_{CE})$ ,

$T_{vj} = 150^{\circ}C$

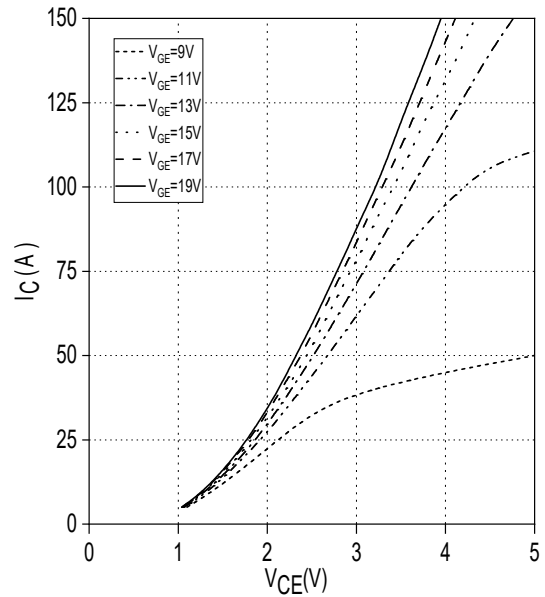

传输特性 IGBT, 逆变器 (典型值)

Transfer characteristic IGBT, Inverter (typical)

$I_C = f(V_{GE})$ ,

$V_{CE} = 20V$

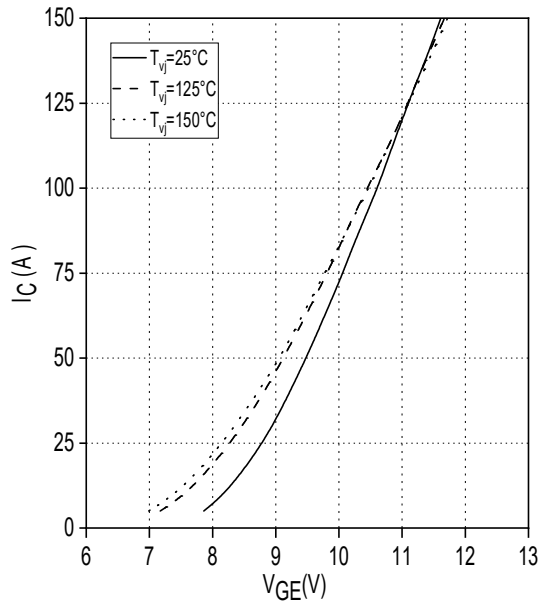

开关损耗 IGBT, 逆变器 (典型值)

switching losses IGBT, Inverter (typical)

$E_{on} = f(I_C), E_{off} = f(I_C), V_{GE} = \pm 15V$ ,

$R_{Gon} = 1.0\Omega, R_{Goff} = 1.0\Omega, V_{CE} = 600V$

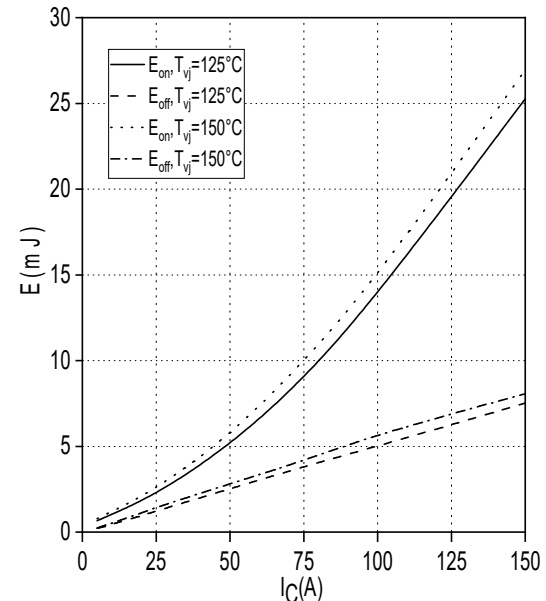

开关损耗 IGBT, 逆变器 (典型值)  
Switching losses IGBT, Inverter (typical)  
 $V_{GE} = \pm 15V, I_C = 75A, V_{CE} = 600V$

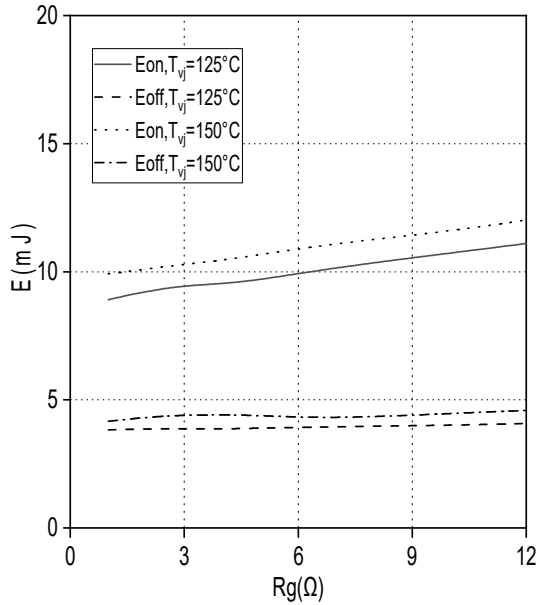

瞬态热阻抗 IGBT, 逆变器  
transient thermal impedance IGBT, Inverter  
 $Z_{thJC} = f(t)$

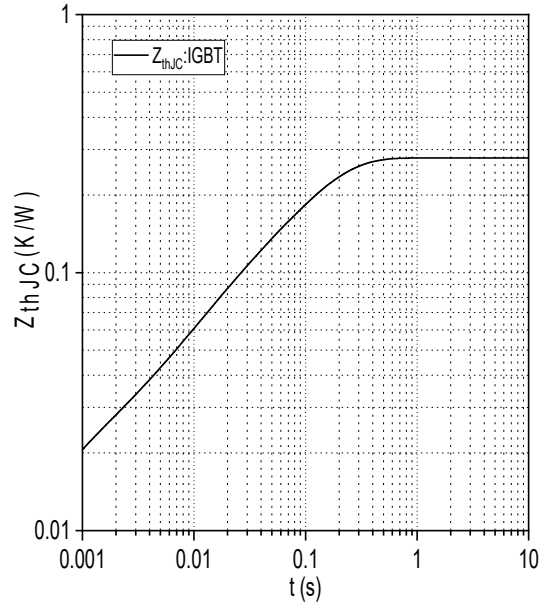

反偏安全工作区 IGBT, 逆变器(RBSOA)  
Reverse bias safe operating area IGBT, Inverter  
(RBSOA)  $I_C = f(V_{CE})$ ,  
 $V_{GE} = \pm 15V, R_{Goff} = 1.0\Omega, T_{vj} = 150^\circ C$

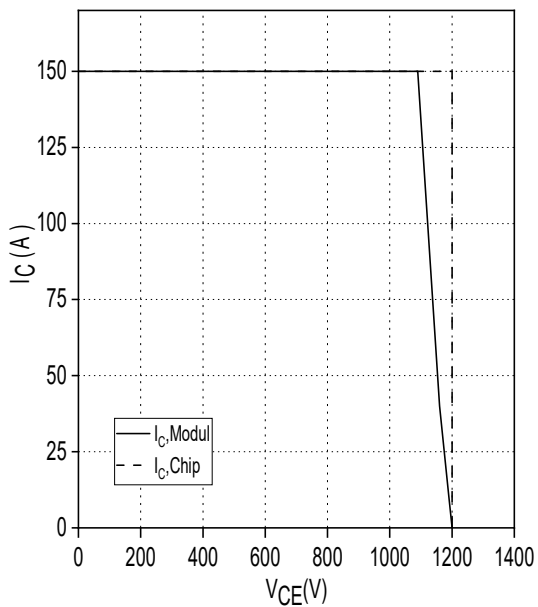

正向偏压特性二极管, 逆变器 (典型值)  
forward characteristic of Diode, Inverter (typical)  
 $I_F = f(V_F)$

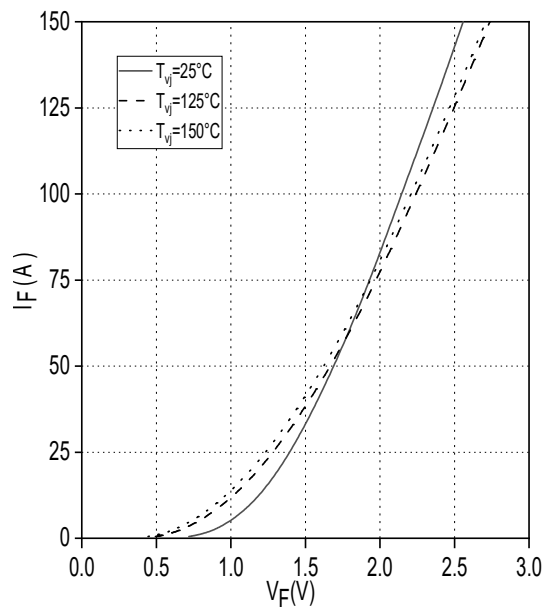

开关损耗二极管,逆变器 开关损耗 (典型值)  
Switching losses Diode, Inverter (typical)

$E_{rec} = f(I_F)$   
 $R_{Gon} = 1.0\Omega, V_{CE} = 600V$

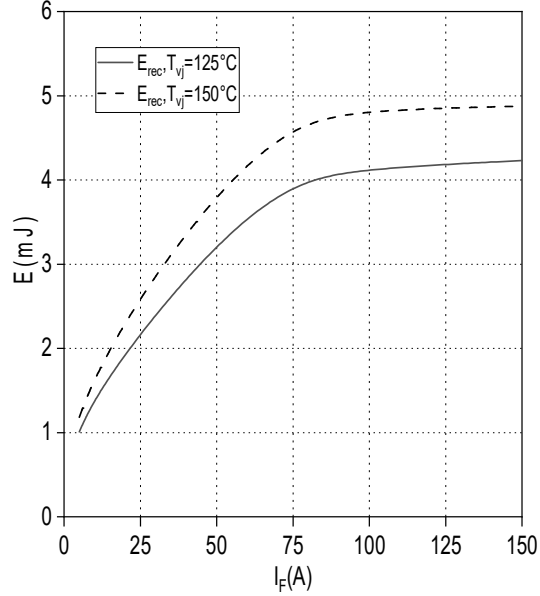

二极管,逆变器 (典型值)  
switching losses Diode, Inverter (typical)

$E_{rec} = f(R_G)$   
 $I_F = 75A, V_{CE} = 600V$

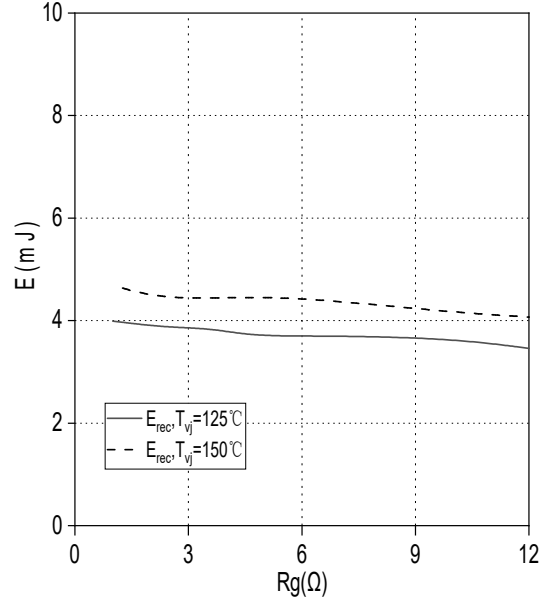

瞬态热阻抗二极管,逆变器  
transient thermal impedance Diode, Inverter

$Z_{thJC} = f(t)$

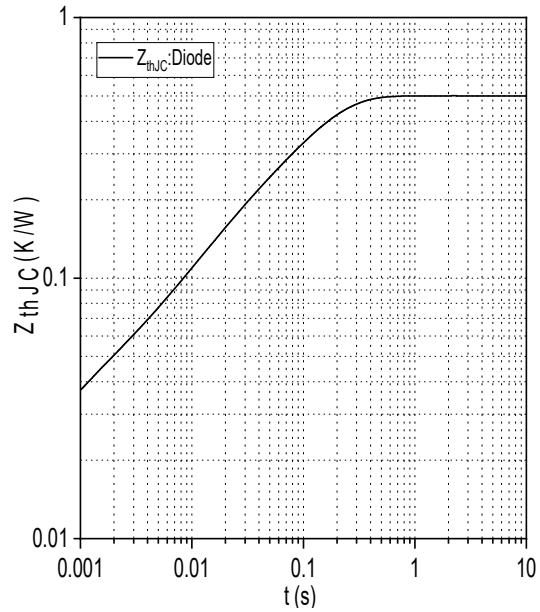

**Internal Circuit:**

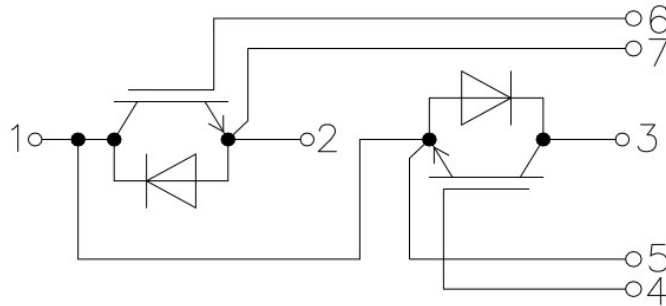

**Package Dimension**  
**Dimensions in Millimeters**

